

LEADERSHIP IN FILTRATION

SOTRAS



**Filters and Products
for Vacuum Pumps**



Commitment to Sustainability

About Sotras... industrial filtration

Sotras was founded in 1975 as a trading business and over the years has transformed itself into an important brand for industrial filters. Sotras manufactures and distributes its own products in Europe and throughout the world. Today Sotras is supplying a top quality range of industrial filters and has specialized in manufacturing filter elements for compressors, vacuum pumps and compressed air applications to suit most requirements in these fields. Sotras can boast its established experience and skill in designing and manufacturing high quality air/oil separators specifically for installation in rotary screw, vane compressors and vacuum pumps.

With regards to vacuum air filters, while in the past Sotras was merely a distributor, over the past 10 years the company has been developing its own production line of housings for which new technologies have been implemented on which rigorous tests are regularly carried out. To cope with the growing demand for a wider range of products and the changing needs of customers, Sotras has made investments for manufacturing products for vacuum pumps in compliance with Sotras quality standards.

We guarantee that all materials used for our products undergo stringent quality tests and specific treatments which ensure long life span and reliable performance. From the beginning, Sotras has strived for perfection by focusing on innovation, reliability and safety of the products.

In the same way, thanks to experience gained from many years of dealing with the compressed air industry, Sotras has developed a flexible product handling system which allows the Logistic Department to satisfy customer requirements by providing faster, safer and reliable deliveries.

Sotras gives attention to human resources training, making the employees able to contribute, individually or collectively, to the attainment of the objectives of the business. Sotras employees, in Technical and Commercial Departments, establish lasting relationships with customers by meeting their expectations through their personal and organizational skills.



SOTRAS headquarter Borgaro To - Italy



SOTRAS logistics Leini - Italy



SOTRAS China Shanghai - China



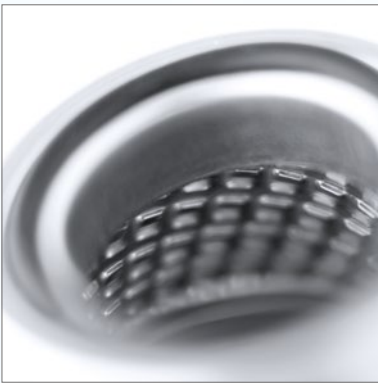

Air cleaners



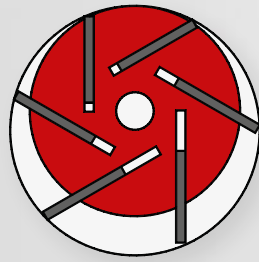

Vacuum pump



Air/oil separators



-  Oil
-  Air
-  Air/oil mix



Oil filters



Vacuum pumps: a constantly growing sector

Vacuum pumps are used in industry and commerce for multiple functions and various applications such as packaging, drying, pick and place and many others. New demands are coming daily and Sotras is ready to respond to every requirement.



Air/Oil Separators



AIR/OIL SEPARATORS FOR VACUUM PUMPS

Sotras production of filters for vacuum applications dates back the beginning of its activity. Thanks to its long experience, today Sotras supplies to majority of the OEMs and the aftermarket with a wide range of highly reliable and efficient products. All air/oil separators are manufactured using materials that withstand high pressures and temperatures and have minimal moisture induced deterioration. The media used in air/oil separators enable us to obtain excellent air/oil separation rates up to 1-3mg/m³.

Draining fleeces are generally ultrasonically welded, and if required, they are equipped with drip edge to facilitate the draining effect. End caps are manufactured in plastic or metal as per requirement and in some cases, they are supplied with anti-detachment systems which can withstand high temperatures. Atex products are available on request.

In order to achieve the best possible separation efficiency and long working life of the element, it is essential that good maintenance procedures are followed along with a use of good quality air and oil filters.



Figure 1

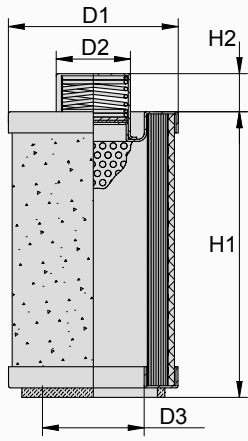

Figure 2

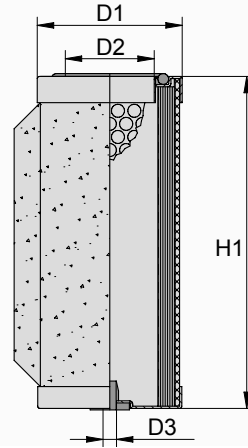

Figure 3

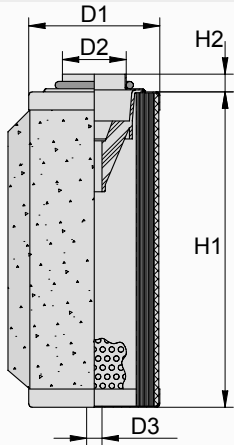

Figure 4

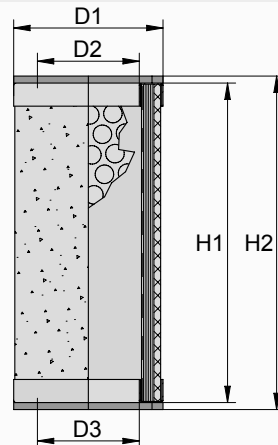

Figure 5

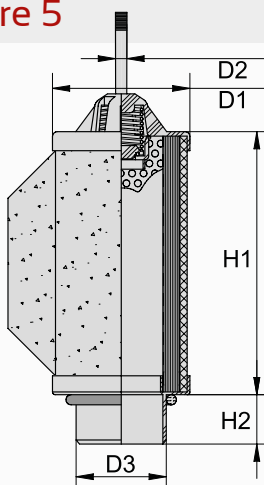

Figure 6

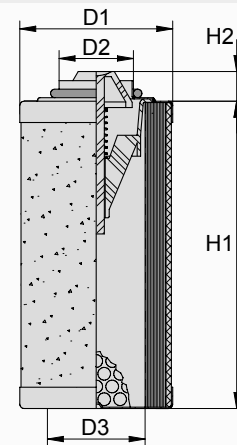

Figure 7

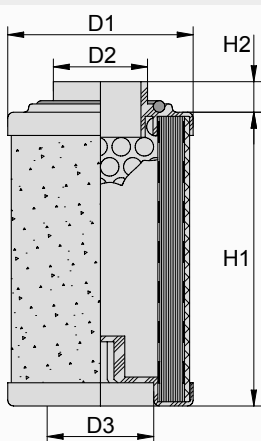
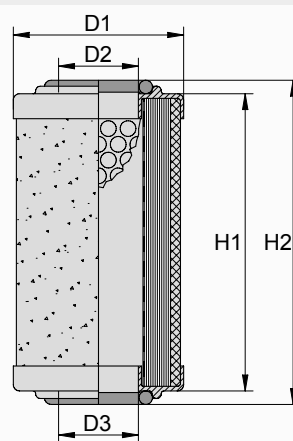

Figure 8



SOTRAS Ref.	Nominal flow Rate		Fig.	D1/mm	D2/mm	D3/mm	H1/mm	H2/mm
	m ³ /min	(cfm)						
DA 1326	0,12	4,2	7	35	G 3/8" Gas	-	52	11
DA 1281	0,15	5,3	1	80	35	48	44,5	18
DA 1542	0,15	5,3	7	35	G 3/8" Gas	-	74	11
DA 1548	0,18	6,3	7	35	G 3/8" Gas	-	84	11
DA 1398	0,20	7,0	3	45	26	9,7	60	8
DA 1474	0,20	7,0	4	54	25	25	65	69
DA 1549	0,25	8,8	7	35	G 3/8" Gas	-	109	11
DA 1050	0,30	10,6	8	55	25	25	68	72
DA 1148	0,30	10,6	1	54	29	25	79	28
DA 1241	0,30	10,6	7	55	M25x2	25	76	13
DA 1321	0,30	10,6	3	45	26	9,7	95,5	8
DA 1051	0,40	14,1	8	72	32	32	74	82
DA 1130	0,40	14,1	3	52	28	-	120	8
DA 1280	0,40	14,1	1	54	29	25	95	28
DA 1409	0,45	15,8	3	45	26	9,7	150	8
DA 1067	0,50	17,6	8	55	25	25	124	129
DA 1238	0,50	17,6	7	72	M32x2	29	82	7
DA 1147	0,50	17,6	1	80	35	48	94	18
DA 1335	0,50	17,6	7	55	M25x2	20	128	12
DA 1103	0,55	19,4	4	64	44	-	99	102
DA 1031	0,55	19,4	4	70	40	40	98	100
DA 1152	0,55	19,4	3	64	40	44	100	9
DA 1227	0,55	19,4	4	69	32	32	100	103
DA 1400	0,60	21,1	1	80	35	48	107	18
DA 1128	0,60	21,1	2	56	24	6	153	-
DA 1392	0,60	21,1	5	54	M6	36,5	153	12
DA 1278	0,65	22,9	4	64	44	44	138	144
DA 1022	0,70	24,6	8	80	45	45	118	124
DA 1206	0,70	24,6	1	54	29	25	175	29
DA 1060	0,80	28,2	3	72	35	-	132	8
DA 1094	0,80	28,2	3	53	28	-	200	8
DA 1061	0,80	28,2	6	72	35	-	132	8
DA 1239	0,80	28,2	7	80	M45x3	32	127	14
DA 1496	0,80	28,2	6	72	35	-	132	10
DA 1417	0,80	28,2	7	49	G 1"	-	132	15
DA 1120	0,90	31,7	4	79	46	46	144	-
DA 1177	1,00	35,2	3	52	M22x1	-	232	12
DA 1134	1,00	35,2	3	53	28	-	232	8
DA 1416	1,00	35,2	7	71	G 1"	-	171	15
DA 1309	1,10	38,7	5	72	M6	21,5	187	26

SOTRAS Ref.	Nominal folw Rate		Fig.	D1/mm	D2/mm	D3/mm	H1/mm	H2/mm
	m ³ /min	(cfm)						
DA 1111	1,20	42,2	3	72	35	8	200	8
DA 1091	1,25	44,0	6	72	32	-	208	8
DA 1516	1,25	44,0	6	72	35	-	208	10
DA 1185	1,30	45,8	1	80	35	48	205	18
DA 1068	1,30	45,8	2	66	41	6	228	-
DA 1319	1,30	45,8	5	72	M6	21,5	224	26
DA 1047	1,50	52,8	3	72	35	-	250	8
DA 1052	1,50	52,8	6	72	35	-	250	8
DA 1110	1,50	52,8	3	72	35	8,5	250	8
DA 1042	1,50	52,8	2	70	38	8	265	-
DA 1203	1,50	52,8	3	70	35	-	250	8
DA 1221	1,50	52,8	4	72	29	9,5	250	-
DA 1386	1,50	52,8	6	72	35	-	250	10
DA 1086	1,80	63,4	4	70	40	40	330	-
DA 1137	1,90	66,9	4	122	89	89	215	-
DA 1254	2,00	70,4	4	100	63	6,5	251	257
DA 1093	2,00	70,4	4	100	68	55	245	251
DA 1020	2,20	77,4	4	106	72	72	218	230
DA 1048	2,20	77,4	3	72	35	-	375	8
DA 1053	2,20	77,4	6	72	35	-	375	8
DA 1204	2,20	77,4	3	70	35	-	375	8
DA 1273	2,20	77,4	4	72	29	9,5	375	-
DA 1300	2,20	77,4	3	72	35	-	375	8
DA 1387	2,20	77,4	6	72	35	-	375	10
DA 1450	2,20	77,4	6	72	35	-	380	8
DA 1069	2,30	81,0	2	66	41	6	397	-
DA 1322	2,30	81,0	5	72	M6	21,5	401	26
DA 1187	2,50	88,0	3	82	50	9,5	380	8
DA 1253	2,50	88,0	4	100	63	6,5	293	296
DA 1092	2,50	88,0	4	100	68	55	285	291
DA 1108	2,60	91,5	1	80	35	48	404	18
DA 1030	2,80	98,6	4	106	72	72	284	296
DA 1049	2,90	102,1	3	72	35	-	500	8
DA 1054	2,90	102,1	6	72	35	-	500	8
DA 1085	2,90	102,1	4	70	40	40	500	-
DA 1388	2,90	102,1	6	72	35	-	500	10
DA 1135	3,60	126,7	3	82	50	6,5	536	8
DA 1115	4,50	158,4	4	122	89	-	460	466
DA 1492	4,70	165,4	4	150	92	10	360	366
DA 1116	6,50	228,8	4	122	89	-	630	636

Vacuum Air Filters

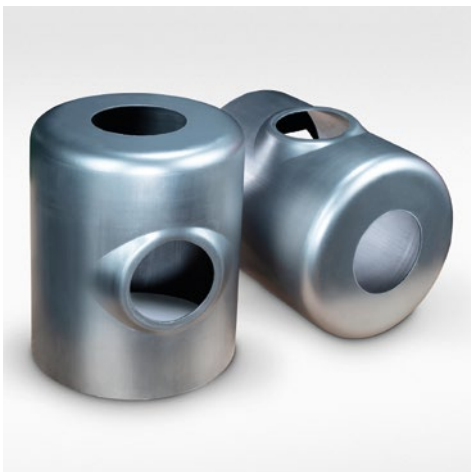

VACUUM AIR FILTERS FOR VACUUM PUMPS

Sotras offers a wide range of air filters which fulfils most requirements in this field. These air filters are designed to obtain high filtration efficiency, low pressure drop and vacuum sealing for maximum equipment performance.

Filter housings are resistant to negative pressure up to 950 mbar and are treated with a special protective coating thereby guaranteeing a longer durability. All filter housings undergo thorough tests to ensure the seals withstand vacuum levels of 300, 600 and 925 mbar. Standard filters are available in G 3/8" up to G 4" connection configuration and NPT solutions too. Flange connection solutions are available on request. The excellent filtration efficiencies of our filters undergo tests in compliance with ISO5011 and ISO12103-1 regulations.

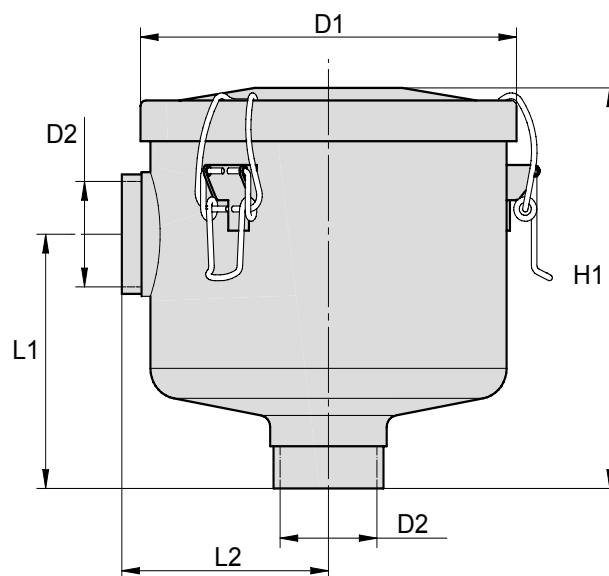

SOTRAS Ref.	D2 Thread	Thread Type	D1 (mm)	H1 (mm)	L1 (mm)	L2 (mm)	Nominal flow rate (m ³ /min)	Paper Element Ref.
SA 6654	G 3/8"	F	77	77	41	46	0,4	SA 6715
SA 6647	G 1/2"	F	101	89	54	59	0,6	SA 6091
SA 6058	G 3/4"	F	101	89	54	59	0,7	SA 6091
SA 6952	G 1"	F	136	91	50	80	1,4	SA 6120
SA 6059	G 1 1/4"	F	136	91	50	80	1,6	SA 6120
SA 6819	1 1/4 NPT	F	136	91	50	80	1,6	SA 6120
SA 6061	G 1 1/4"	F	171	171	98	108	1,8	SA 6122
SA 6820	1 1/4 NPT	F	171	170	108	98	1,8	SA 6122
SA 6821	1 1/2 NPT	F	171	168	106	96	1,8	SA 6122
SA 6648	G 1 1/2"	F	171	196	131	104	3,2	SA 6651
SA 6822	1 1/2 NPT	F	171	188	126	100	3,2	SA 6651
SA 6649	G 2"	F	200	248	127	112	5,2	SA 6096
SA 6823	2" NPT	F	200	249	127	112	5,2	SA 6096
SA 6060	G 2 1/2"	F	200	249	127	112	6	SA 6096
SA 6824	2 1/2 NPT	F	200	249	127	112	6	SA 6096
SA 6650	G 3"	F	282	245	147	192	9,2	SA 6095
SA 6652	G 4"	F	282	260	162	200	12	SA 6095
SA 6825	4" NPT	F	282	260	162	200	12	SA 6095
SA 6749	G 3"	F	282	445	380	190	18	SA 6005
SA 6750	G 4"	F	360	640	450	230	21	SA 6025

Air Filters Elements



AIR FILTERS ELEMENTS FOR VACUUM PUMPS

Sotras offers a complete range of filtering cartridges able to fulfil most of the requirements of the sector. Cellulose, polyester, supplied with or without wire mesh support depending on specific needs, stainless steel and fibreglass configurations are available. Filtration degrees can vary from 3 to 60 micron and the materials used ensure utilization from -20°C up to +120°C. Replacement cartridges are supplied in special packaging to avoid possible contaminations and are generally equipped with additional sets of gaskets to be used, if necessary, while servicing is carried out. The metallic components of the cartridges undergo accurate surface treatment to ensure a good resistance level to corrosion. Dimensions of elements are 100% tested, to ensure proper operation performance.

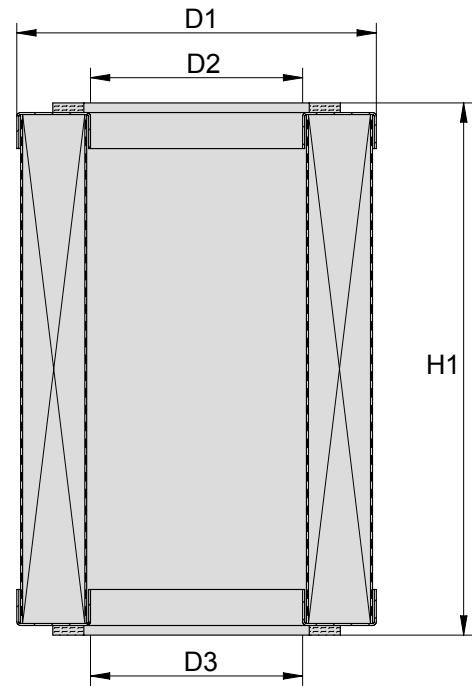

SOTRAS Ref.	Paper Element	Poliestere Element	Special Poliestere Element	Stainless Steel Element	H1 (mm)	D1 (mm)	D2 (mm)	D3 (mm)
SA 6654	SA 6715	SA 7255	SA 7256	SA 7257	57,5	51	-	23,5
SA 6058	SA 6091	SA 7202	SA 7228	SA 7203	69	64	-	38
SA 6647	SA 6091	SA 7202	SA 7228	SA 7203	69	64	-	38
SA 6952	SA 6120	SA 7059	SA 7229	SA 7204	71	98	60,5	60,5
SA 6059	SA 6120	SA 7059	SA 7229	SA 7204	71	98	60,5	60,5
SA 6819	SA 6120	SA 7059	SA 7229	SA 7204	71	98	60,5	60,5
SA 6061	SA 6122	SA 7006	SA 7230	SA 7000	123	126	64,5	64,5
SA 6820	SA 6122	SA 7006	SA 7230	SA 7000	123	126	64,5	64,5
SA 6821	SA 6122	SA 7006	SA 7230	SA 7000	123	126	64,5	64,5
SA 6648	SA 6651	SA 7060	SA 7231	SA 7205	155	126	65	65
SA 6822	SA 6651	SA 7060	SA 7231	SA 7205	155	126	65	65
SA 6649	SA 6096	SA 6943	SA 7232	SA 7001	218	150	88,5	88,5
SA 6823	SA 6096	SA 6943	SA 7232	SA 7001	218	150	88,5	88,5
SA 6060	SA 6096	SA 6943	SA 7232	SA 7001	218	150	88,5	88,5
SA 6824	SA 6096	SA 6943	SA 7232	SA 7001	218	150	88,5	88,5
SA 6650	SA 6095	SA 6899	SA 7258	SA 7259	165	212	145	145
SA 6652	SA 6095	SA 6899	SA 7258	SA 7259	165	212	145	145
SA 6825	SA 6095	SA 6899	SA 7258	SA 7259	165	212	145	145
SA 6749	SA 6005	SA 7260	SA 7261	SA 7262	377	197	9	103
SA 6750	SA 6025	SA 7263	SA 7264	SA 7265	493	242	12	132

Cartridges and Accessories



CARTRIDGES AND ACCESSORIES FOR VACUUM PUMPS

Sotras has developed and can offer most of the air and oil filter cartridges used in vacuum pumps. Flexibility in our manufacturing process allows us to offer personalization of the filter irrespective of the quantities. Both spin-on elements and air cartridges are available in standard cellulose version and with special filter media such as synthetic media and fiberglass media. To integrate the range of products for vacuum pumps, Sotras has included some accessories necessary for maintenance operations. Gaskets, O-rings, vanes and other accessories are developed with high tech materials to ensure safe and durable use in extreme conditions.

Quality and Guarantee

We would like to emphasize that Sotras filters undergo stringent quality control and are frequently tested in order to ensure satisfactory operation in the application of which they are designed.

Evidence of the high quality of our products lies in the fact that Sotras manufactures original equipment for some of the most important compressor and vacuum pumps manufacturers, to some of which Sotras guarantees product exclusivity. We guarantee that filters produced by Sotras are free from defects either in materials or construction, always provided that the machinery is maintained in accordance with manufacturer's recommendations and filters are correctly installed and changed. Sotras will replace any item found to be defective as described above but will not be held responsible for any other replacement or contingencies or consequential loss.

Sotras' organization has been certified for its quality management systems since 1999.

Its first certification was in compliance with UNI EN ISO 9002-94.

In 2003, Sotras has obtained certification to UNI EN ISO 9001-2000 and currently to ISO 9001-2015.

Recently Sotras products have been certified in compliance with EAC regulations for the Russian market.



kiwa

Reg. Number: 926 - A Valid from: 2018-06-04
 First issue date: 1999-04-14 Last charge date: 2018-06-04
 Valid until: 2021-06-05 Ref. Sector: EA: 18

**Quality Management System Certificate
 ISO 9001:2015**

We certify that the Quality Management System of the Organization:
SOTRAS S.r.l.
 Is in compliance with the standard UNI EN ISO 9001:2015 for the following products/services:
 Development and manufacturing of industrial filters.

Chief Operating Officer
 Giampiero Bolcredi

The maintaining of the certification is subject to annual surveillance and dependent on the observance of Kiwa Control Italia contractual requirements.
 This certificate is composed of 1 page.



EAC **ЕВРАЗИЙСКИЙ ЭКОНОМИЧЕСКИЙ СОЮЗ
 ДЕКЛАРАЦИЯ О СООТВЕТСТВИИ**

Заявитель: Общество с ограниченной ответственностью «Техпромимпорт»
 Основной государственный регистрационный номер: 1153256016682.
 Место нахождения (адрес юридического лица) и адрес (адреса) места осуществления деятельности:
 241013, Россия, Брянская область, город Брянск, улица Лейтенанта, дом 36А, офис 702;
 номер телефона: + 79308267001; адрес электронной почты: techpromimport@gmail.com
 в лице Генерального директора Горелова Ивана Васильевича,
 заявляет, что Оборудование химическое, нефтегазоперерабатывающее: сепараторы DA****,
 DV****, DC****, DE****, DF****; воздушные фильтры SA****; масляные фильтры SH****;
 воздушные микрофильтры SM****. Продукция изготовлена в соответствии с Директивой 2006/42/EC
 «Машин и механизмы».
 Изготовитель: SOTRAS S.R.L.
 Место нахождения (адрес юридического лица) и адрес (адреса) места осуществления деятельности по
 изготовлению продукции: Via Donatello, 13 - 10071 Borgaro Torinese (To), Италия.
 Код ТН ВЭД ЕАЭС: 8421 39 200 9, 8421 29 000 9.
 Серийный выпуск.
 Соответствует требованиям
 Технического регламента Таможенного союза
 ТР ТС 010/2011 «О безопасности машин и оборудования».
 Декларация о соответствии принята на основании
 Протокола испытаний № 007-05/18 от 25.05.2018 года испытательной лаборатории Общества с
 ограниченной ответственностью «ЛНХ-НГБ».
 Схема декларирования 1Д.
 Дополнительная информация
 Условия хранения продукции в соответствии с ГОСТ 15150-69.
 Срок хранения и срок службы указываются в прилагаемой к продукции товаросопроводительной
 и/или эксплуатационной документации.
 Декларация о соответствии действительна с даты регистрации по 05.06.2023 включительно.
 Горелов Иван Васильевич
 (подпись) (ф.и.о. заявителя)
 Регистрационный номер декларации о соответствии: ЕАЭС № RU Д-Т.АТ15.В.02496
 Дата регистрации декларации о соответствии: 06.06.2018



SOTRAS

CERTIFICATE OF RoHS COMPLIANCE

This document certifies that SOTRAS's products, listed below, are fully:

- RoHS compliant as of January 2002 in accordance with EU RoHS Directive 2011/65/EU (restriction of the use of certain hazardous substances in electrical and electronic equipment),
- RoHS compliant as of January 2002 in accordance with EU ELV Directive 2000/53/EC (recovery of end-of-life vehicles and their components),

Products	Family Code
AIR / OIL SEPARATORS	DA - DB - DC - DE - DF
HYDRAULIC FILTERS	SH
AIR FILTERS	SA - SM
ACCESSORIES	SR - SK - NP

Based on information provided by our suppliers, SOTRAS declares that the products listed above do not contain any of the restricted substances listed in the table below in concentrations exceeding the Maximum Concentration Value (MCV) referred to RoHS and ELV Directives.

Substance	Threshold limit by weight	Applicable product category
Asbestos	0,1%	Gaskets
Cadmium (Cd)	0,01%	Plated components
Hexavalent chromium (Cr+6)	0,1%	Anti-corrosion coating of steel components
Mercury (Hg)	0,1%	Floot valves
Lead (Pb)	0,1%	Solders

We hereby declare that RoHS and ELV restricted substances are not intentionally added to our products and unintentional amount of the restricted substances are within these limitations of RoHS and ELV Directives.

However the above filters are designed and manufactured in accordance with the national sound engineering practice and the correct quality control procedures according to our Quality Management System, Certificate ISO 9001:2015, in order to ensure compliance to International Standards and safe use.

Giampiero Bolcredi
 Authorized Signature
 Director of Quality

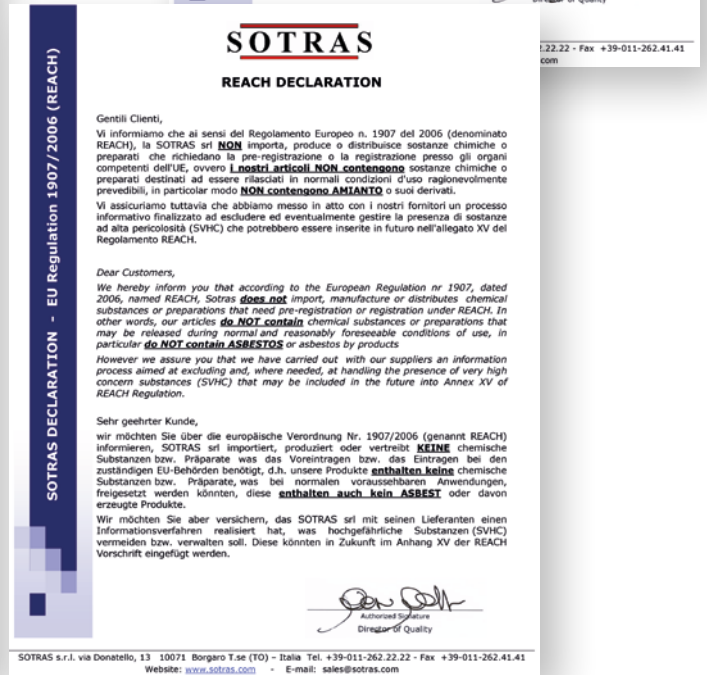

SOTRAS

REACH DECLARATION

Gentili Clienti,
 Vi informiamo che ai sensi del Regolamento Europeo n. 1907 del 2006 (denominato REACH), la SOTRAS si **NON** importa, produce o distribuisce sostanze chimiche o preparati che richiedono la pre-registrazione o la registrazione presso gli organi competenti dell'UE, ovvero **I nostri articoli NON contengono** sostanze chimiche o preparati destinati ad essere rilasciati in normali condizioni d'uso ragionevolmente prevedibili, in particolare modo **NON contengono AMIANTO** o suoi derivati.
 Vi assicuriamo tuttavia che abbiamo messo in atto con i nostri fornitori un processo informativo finalizzato ad escludere ed eventualmente gestire la presenza di sostanze ad alta pericolosità (SVHC) che potrebbero essere inserite in futuro nell'allegato XV del Regolamento REACH.

Dear Customers,
 We hereby inform you that according to the European Regulation nr 1907, dated 2006, named REACH, Sotras **does not** import, manufacture or distributes chemical substances or preparations that need pre-registration or registration under REACH. In other words, our articles **do NOT contain** chemical substances or preparations that may be released during normal and reasonably foreseeable conditions of use, in particular **do NOT contain ASBESTOS** or asbestos by products.

However we assure you that we have carried out with our suppliers an information process aimed at excluding and, where needed, at handling the presence of very high concern substances (SVHC) that may be included in the future into Annex XV of REACH Regulation.

Sehr geehrter Kunde,
 wir möchten Sie über die europäische Verordnung Nr. 1907/2006 (genannt REACH) informieren, SOTRAS si **NON** importiert, produziert oder vertreibt **KEINE** chemische Substanzen bzw. Präparate was das Voreinbringen bzw. das Einbringen bei den zuständigen EU-Behörden benötigt, d.h. unsere Produkte **enthalten keine** chemische Substanzen bzw. Präparate, was bei normalen voraussetzbaren Anwendungen, freigesetzt werden könnten, diese **enthalten auch kein ASBEST** oder davon erzeugte Produkte.
 Wir möchten Sie aber versichern, das SOTRAS si mit seinen Lieferanten einen Informationsverfahren realisiert hat, was hochgefährliche Substanzen (SVHC) vermeiden bzw. verwalten soll. Diese könnten in Zukunft im Anhang XV der REACH Vorschrift eingefügt werden.

Giampiero Bolcredi
 Authorized Signature
 Director of Quality

SOTRAS s.r.l. via Donatello, 13 10071 Borgaro T.se (TO) - Italia Tel. +39-011-262.22.22 - Fax +39-011-262.41.41
 Website: www.sotras.com - E-mail: sales@sotras.com

SOTRAS

Via Donatello, 13
10071 Borgaro Torinese - Italy
T +39.011.262.22.22
F +39.011.262.41.41
www.sotras.com